

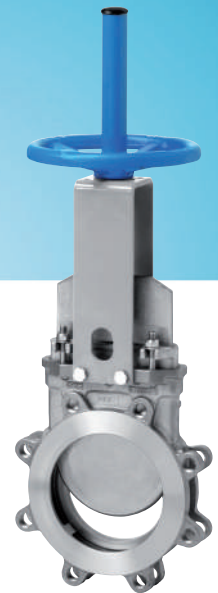

ORBINOX

VALVE SOLUTIONS IN MORE THAN 70 COUNTRIES

Valves for
pulp & paper





Valves for pulp & paper



ORBINOX was founded in Tolosa (northern Spain) during the late 60's as a manufacturer of knife gate valves servicing the local pulp and paper industry. Recognizing that success is built on understanding customers' processes and by finding innovative solutions for difficult applications, we focused on increasing our engineering capabilities and developed many engineered valves for diverse industrial sectors. In the late 70's the company introduced the knife gate valve line in North America and other parts of the world. Today we have manufacturing plants in Spain, Canada, China, India, UK and

Brazil, sales and distribution centers in Spain, UK, Germany, France, Canada, USA, Brazil, Chile, Peru, China and India; and a network of distributors worldwide.

ORBINOX offers a wide range of knife gate valves for handling diverse applications in the pulp & paper, water, wastewater, bulk handling and other process industries. With more than 55 years experience in the industrial market worldwide, and has become a well-known innovative knife gate manufacturer responding to new industrial developments.



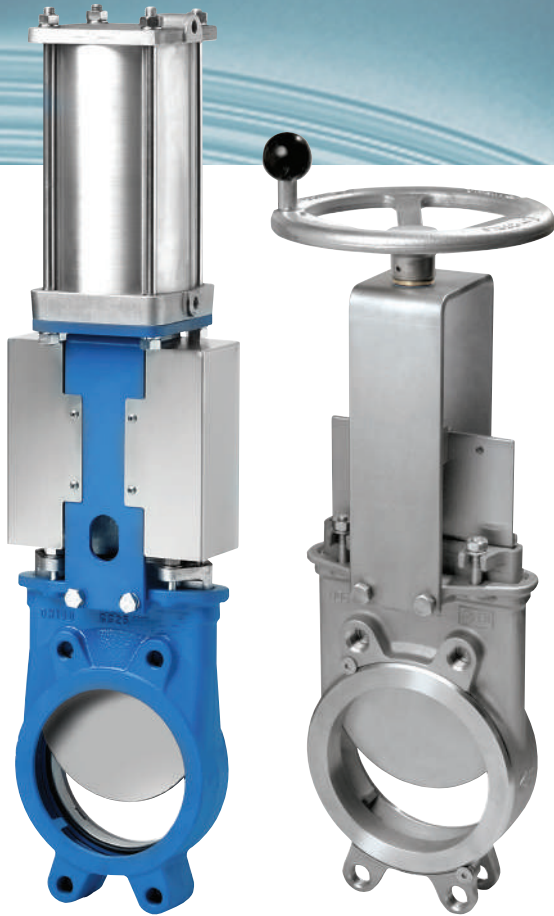

SER. 10_(EX) EK/HK

Unidirectional semi-lugged knife gate valves for general service, assure non-clogging shut off with suspended solids. Fully modular design, available in multiple configurations and sizes, including high-alloy steels.

The **EK/HK** valves are the high performance versions with a complete stainless steel configuration. Their cast retainer ring system (K type) improves tightness and simplifies maintenance operations.

Reliable for pulp concentrations up to 5%

Sizes: DN 2" to 48"

Working pressure:

SER. 10 (EX)

DN 2"-10" (150 psi / 10 bar)

DN 12"-16" (90 psi / 6 bar)

DN 18" (75 psi / 5 bar)

DN 20"-24" (60 psi / 4 bar)

DN 28"-48" (30 psi / 2 bar)

EK

DN 2"-3" (150 psi / 16 bar)

DN 4"-10" (150 psi / 10 bar)

DN 12"-16" (90 psi / 6 bar)

DN 18" (75 psi / 5 bar)

DN 20"-24" (60 psi / 4 bar)

DN 28"-48" (30 psi / 2 bar)

HK

DN 4"-12" (150 psi / 10 bar)

The **HK** valve is designed to work with off-seating pressures of 50 psi (3,5 bar) for DN 4"/6", 45 psi (3 bar) for DN 10" and 30 psi (2 bar) for DN 12"

Flange drilling: PN 10, ASME B16.5 (Class 150) (Other on request)

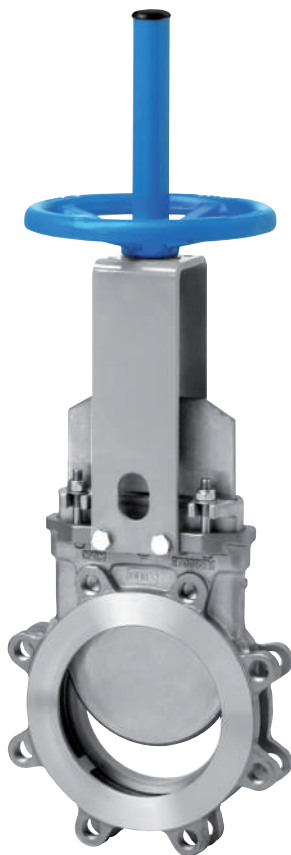

SER. 20_(ET)

Heavy duty unidirectional lugged knife gate valve for general service designed according to MSS-SP-81 and TAPPI TIS 405-8, with stainless steel body, assures non-clogging shut off with suspended solids.

Fully modular design, available in multiple configurations and sizes.

Reliable for pulp concentrations up to 5%

Sizes: DN 2" to 36"

Working pressure: DN 2"-24" (150 psi / 10 bar)

DN 30" (100 psi / 7 bar)

DN 36" (100 psi / 7 bar)

Flange drilling: PN 10, ASME B16.5 (Class 150) (Other on request)

SER.11 (EB) SER.22(BT)



Bi-directional knife gate valves with perimeter seal removing grooves that can collect pulp and prevent the valve from operating properly. Its unique full-bore design with no cavities in the seating area gives excellent flow characteristics and avoids clogging. One or two piece valve body depending on valve size.

Reliable for pulp concentrations up to 5%

Sizes: DN 2" to 48"
Working pressure: DN 2"-3" (150 psi / 16 bar)
DN 4"-10" (150 psi / 10 bar)
DN 12"-16" (90 psi / 6 bar)
DN 18" (75 psi / 5 bar)
DN 20"-24" (60 psi / 4 bar)
DN 28"-48" (30 psi / 2 bar)

The **SER.22(BT)** valve is the heavy duty lugged version designed according to MSS-SP-81 and TAPPI TIS 405-8 with stainless steel body.

Sizes: DN 2" to 36"
Working pressure: DN 2"-24" (150 psi / 10 bar)
DN 30"-36" (100 psi / 7 bar)
Flange drilling: PN 10, ASME B16.5 (Class 150) (Other on request)

SER.30(TL) SER.32(TK) SER.34(TH)

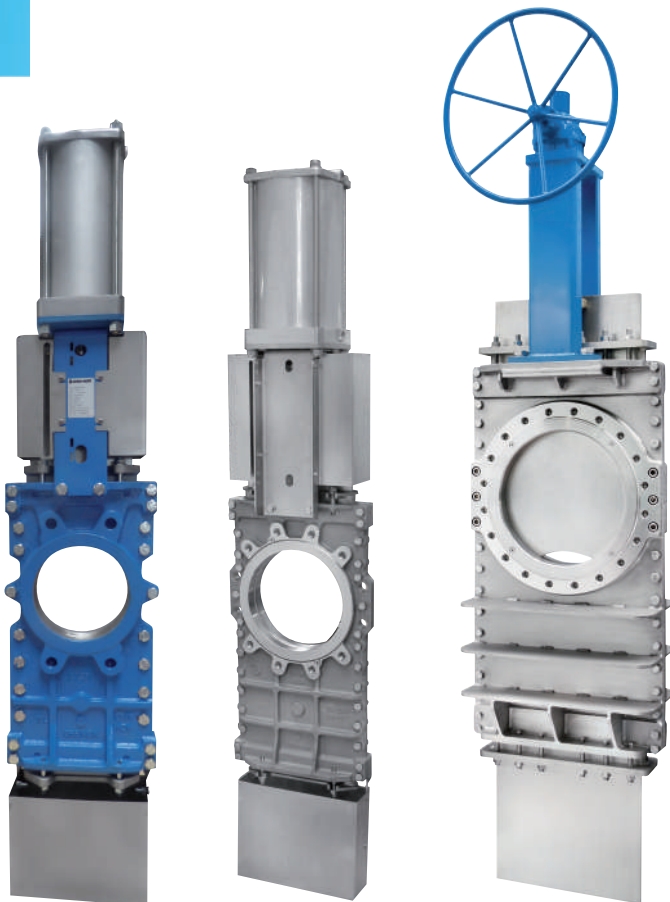

Bi-directional through conduit knife gate valves for high pulp concentrations and other demanding applications.

All versions have a two piece valve body with internal sliders for a smooth gate travel. Fully modular design, available in multiple configurations and sizes, including high-alloy steels.

The **TK** valve is the high performance version. Its cast retainer ring system (K type) improves tightness and simplifies maintenance operations.

Reliable for pulp concentrations up to 12%

Sizes: DN 2" to 40"

Working pressure:

SER.30(TL)	SER.32(TK)
DN 2"-5" (150 psi / 10 bar)	DN 2"-10" (150 psi / 10 bar)
DN 6"-10" (115 psi / 8 bar)	DN 12"-36" (90/115 psi or 6/8 bar)
DN 12"-16" (90 psi / 6 bar)	
DN 18" (75 psi / 5 bar)	
DN 20"-24" (60 psi / 4 bar)	
DN 28"-40" (30 psi / 2 bar)	

The **SER.34(TH)** valve is a customized heavy duty version suitable for high pressure.

Sizes: Any size / Any pressure.

Flange drilling: PN 10, ASME B16.5 (Class 150) (Other on request)

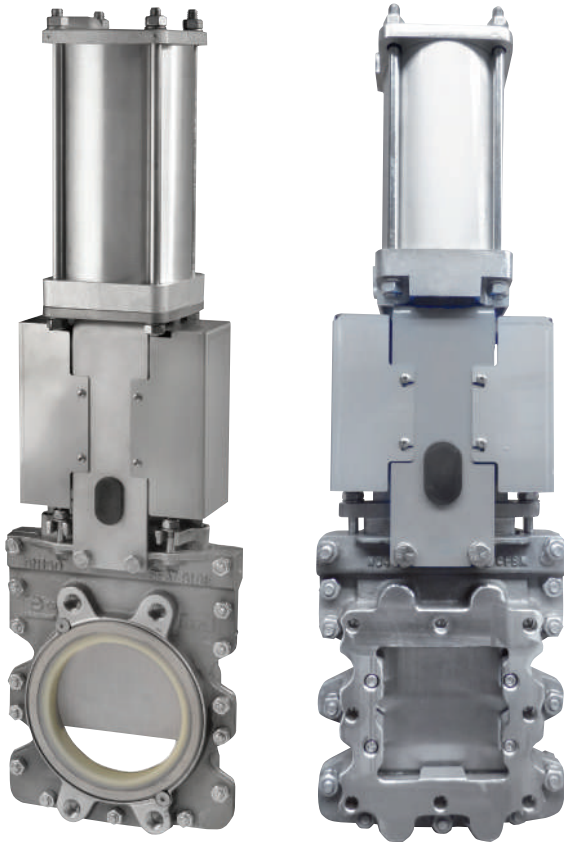

SER.70(CR) CK

Knife gate valves suitable for reject handling in recycling applications, like junk or sand traps, cleaners, etc.

The **SER.70(CR)** valve has a two piece body with round inlet and square outlet (larger than the inlet) ensuring non-jamming operation. Available in multiple configurations and sizes, such as gate surface treatments or double gland systems.

Sizes: DN 4" to 24"

Working pressure:

DN 4"-16" (100 psi / 7 bar)

DN 20"-24" (60 psi / 4 bar)

The **CK** valve is the fabricated square inlet and outlet version (larger than the inlet), particularly used as bottom valve in Junk Trap systems.

Flange drilling: PN 10, ASME B16.5 (Class 150)
(Other on request)

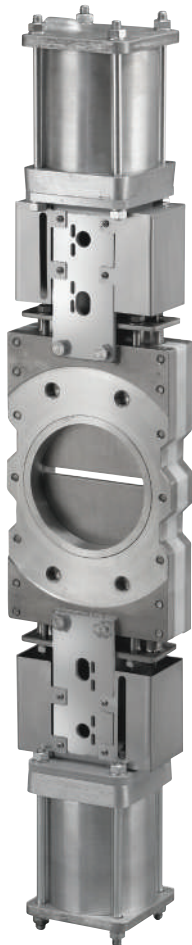

SER.80(DT)

Double gate bi-directional knife gate valve suitable for handling highly concentrated or contaminated media in recycling applications.

The two piece body with its fully lined low friction interior and double gate design offers extremely fast opening and closing times.

Sizes: DN 4" to 24"

Working pressure:

DN 4"-10" (150 psi / 10 bar)

DN 12"-16" (90 psi / 6 bar)

DN 18" (75 psi / 5 bar)

DN 20"-24" (60 psi / 4 bar)

Flange drilling: PN 10, ASME B16.5 (Class 150)
(Other on request)

JUNK TRAP

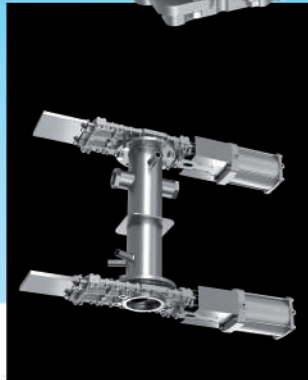
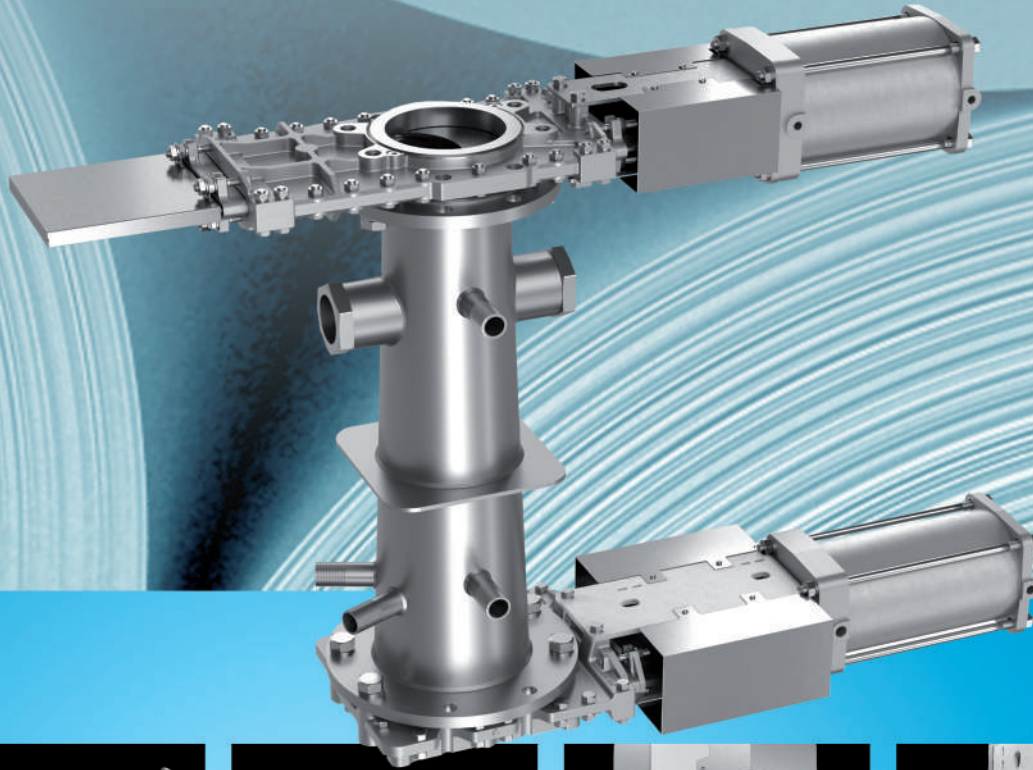

Solutions

The **ORBINOX** Junk Trap solution is conceived for reject removal applications in the Pulp and Paper industry, such as pulpers, high consistency cleaners.

The combination of valves depends on the specific application requirements and the customer's experience.

ORBINOX offers numerous valve combinations to better suit each particular case.

The most common solution is composed of **SER.32(TK)** at the inlet and **SER.70(CR)** at the outlet, with a transition between both valves. Other possible combinations: **SER.70/SK (CR/SK)**, **SER.70/SER.70 (CR/CR)**, **SER.32/SER.32 (TK/TK)**, **EK/SER.32 (EK/TK)**, **SER.20/SER.70 (ET/CR)**.

The **SER.70-SK (CR-SK)** combination is the high performance solution for the most severe service conditions.

Accessories

The valves can be fitted with different accessories to make them more durable and better able to withstand the wear caused by rejects. These include bonnets, double packing systems, flush-ports, stainless steel scrapers, as well as different surface hardening treatments of gates and rings.

Seating options

Depending on the service conditions and to improve their performance, the valves can optionally be supplied with different seat configurations; polyurethane, bronze sliders, anti-vortex system, etc.

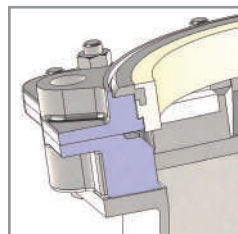

Polyurethane

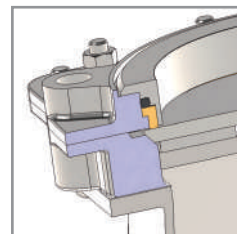

Bronze

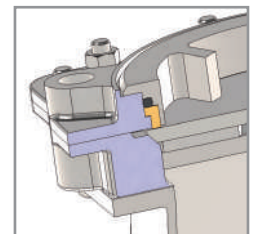

Bronze + Vortex breaker K-Ring

Other valves



SER.35(RM)
Tilting disc valve



SER.45(TP)
Sampling valve

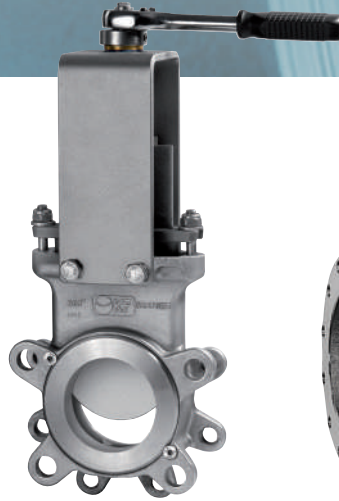

KP
Transmitter
isolation valve

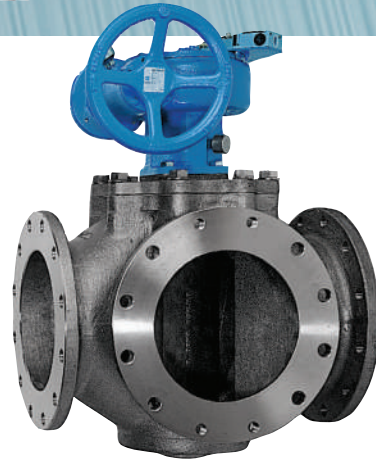

3/4 V
3/4 way valve

Seating options

SER.10(EX)
SER.20(ET)

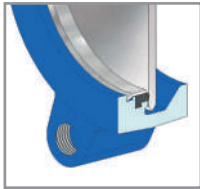

Resilient A type
(standard)

EK
HK

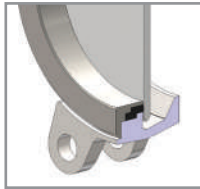

Resilient K type

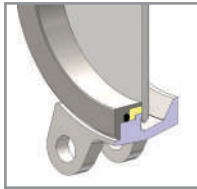

PTFE K type

SER.30(TL)

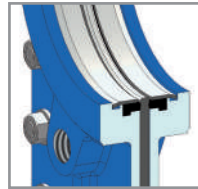

Resilient A type

SER.11(EB)

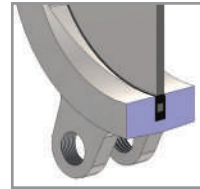

Resilient seat



Metal to metal

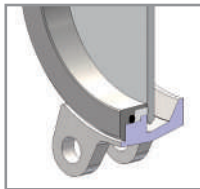

Metal to Metal
K type

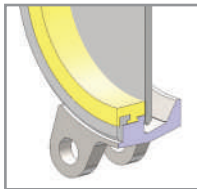

Polyurethane
K type

SER.32(TK)

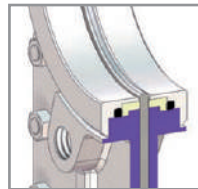

Resilient
K type

SER.22(BT)

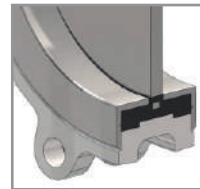

Resilient seat

Actuator types



Bevel gear



Handwheel
non-rising stem



Handwheel
rising stem



Pneumatic
cylinder



Electric
actuator



Single acting
cylinder



Hydraulic
cylinder



Chainwheel



Lever



ORBINOX

VALVE SOLUTIONS IN MORE THAN 70 COUNTRIES

MEMBER OF THE  GROUP

ORBINOX VALVES INTERNATIONAL

Parque Tecnológico de San Sebastián
Pº Mikeletegui, 71 - planta 1ª
20009 DONOSTIA-SAN SEBASTIAN, SPAIN
Tel.: + 34 943 69 80 30
Fax: + 34 943 30 92 83
e-mail: ovi@orbinox.com

EUROPE

ORBINOX S.A.
ANOETA, GIPUZKOA • SPAIN
orbinox@orbinox.com

ORBINOX UK
CHICHESTER, WEST SUSSEX • UK
uk@orbinox.com

ORBINOX COMERCIAL
BELAUNTA, GIPUZKOA • SPAIN
comercial@orbinox.com

ORBINOX GERMANY
SCHWERTE, NRW • GERMANY
germany@orbinox.com

ORBINOX FRANCE
GENAS, REGION LYONNAISE • FRANCE
france@orbinox.com

DAMPER TECHNOLOGY
EASTWOOD, NOTTINGHAM • UK
sales@dampertechnology.com

ASIA

ORBINOX CHINA
BEIJING / SHANGHAI • CHINA
china@orbinox.com

ORBINOX INDIA
COIMBATORE, TAMIL NADU • INDIA
india@orbinox.com

DAMPER TECHNOLOGY
COIMBATORE, TAMIL NADU • INDIA
sales.india@dampertechnology.com

AMERICA

ORBINOX CANADA
LAVAL, QUEBEC • CANADA
canada@orbinox.com

ORBINOX USA
AMORY, MISSISSIPPI • USA
usa@orbinox.com

ORBINOX BRAZIL
INDAIATUBA, SÃO PAULO • BRAZIL
brasil@orbinox.com

ORBINOX CHILE
SANTIAGO • CHILE
chile@orbinox.com

ORBINOX PERU
LIMA • PERU
peru@orbinox.com

www.orbinox.com

